

Front view AW9/12-R32-M

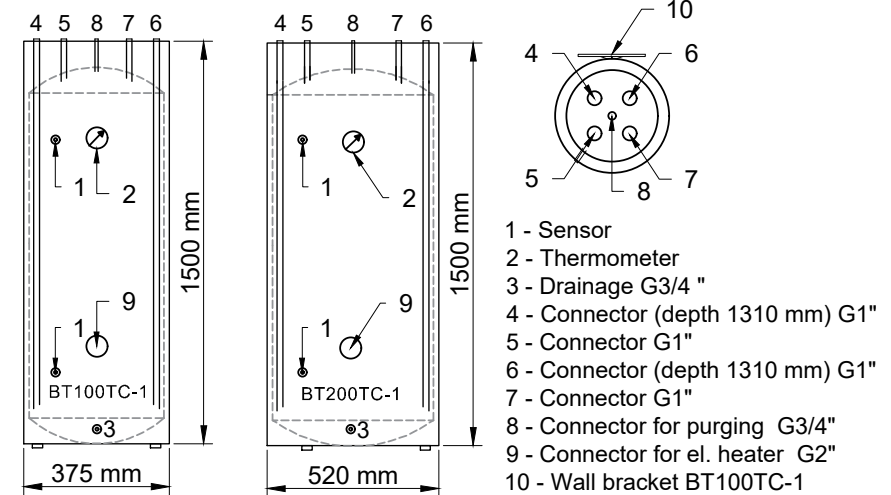
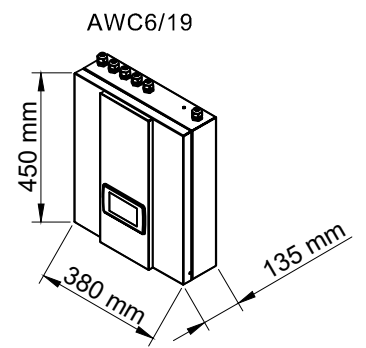
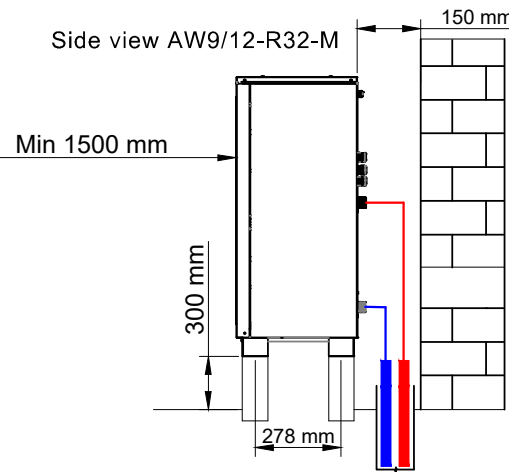
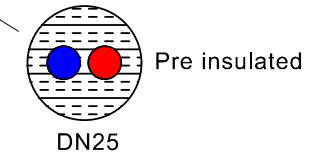
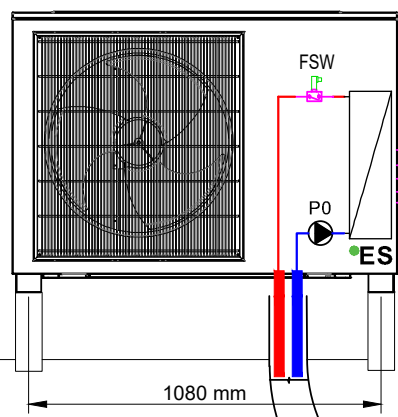

Classification of the Drawing/Klassifizierung/Klasifikacija risbe:	Date, Datum : 21.2.2020
EIS	Drawing ID/Zeichnungs ID/ Oznaka risbe: Ver1
Title/Title: AWC9/12-R32-M, DHW tank, buffer BT100TC-1/200TC-1, 2 x mixing heating / cooling circuit	Revision/Prüfung/Revizija: MK
Naziv:	